

**Manufacturer:**

Phonak Communications AG  
Laenggasse 17  
CH-3280 Murten  
Switzerland

**EU Representative:**

Phonak GmbH  
D-70736 Fellbach-Oeffingen  
Germany

[www.phonak.com/roger](http://www.phonak.com/roger)



# Roger inspiro

User Guide



röger



**PHONAK**  
life is on

---

# Contents

1. Welcome	7
2. Getting to know your Roger inspiro	8
3. Getting started	10
3.1 Charging Roger inspiro	10
3.2 Switching Roger inspiro on	12
3.3 Wearing Roger inspiro	13
3.4 Wearing the iLapel microphone	17
3.5 Wearing the optional EasyBoom microphone	19
3.6 Muting the microphone	21
3.7 Activating the keypad lock	22
4. Using Roger inspiro	23
4.1 How to access Roger inspiro's menu	23
4.2 Using Roger inspiro to connect devices in a network	23
4.2.1 Connecting Roger receivers	24
4.2.2 Connecting FM receivers	25
4.2.3 Connecting Roger DigiMaster devices	26

---

4.3 Using Roger inspiro in a classroom network (Primary Talker)	26
4.4 Using Roger inspiro in a conference room network (Equal Talker)	27
4.5 Creating a Sub-Network for use by a teaching assistant (SubNet / EndSub)	28
4.6 Using Roger inspiro to check devices (Check)	29
4.7 Using Roger inspiro to manage Roger receiver settings (Check / Manage)	30
<b>5. More detailed information</b>	<b>32</b>
5.1 Checking the Roger inspiro software version	32
5.2 Customizing the softkeys	32
5.3 Changing the Application mode	33
5.4 Adjusting the audio volume of Roger DigiMaster loudspeakers	34
5.5 Adjusting the volume of a Roger DigiMaster's external audio input	34
5.6 Joining an existing network (JoinNet)	35
5.7 Creating a new network ID (NewNet)	35

---

## Contents

5.8	Viewing list of connected devices	36
5.9	Viewing a device's total usage time	37
5.9.1	Viewing Roger inspiro's total usage time	37
5.10	Changing Roger inspiro's FM channel	38
5.11	Finding a new FM channel in the Roger inspiro	38
5.12	Changing FM receiver settings	39
5.13	Re-activating the first-time use menu	41
5.14	Changing menu type	42
5.15	Connecting audio devices with Roger inspiro	42
5.16	Verification mode	43
5.17	Roger inspiro settings	44
5.18	Help	45
5.19	Technical data	46
5.20	About accessories	47
6.	Troubleshooting	48
7.	Important information	51

---

<b>8. Service and warranty</b>	<b>58</b>
<b>9. Information and explanation of symbols</b>	<b>60</b>



---

# 1. Welcome

Congratulations on choosing Roger inspiro from Phonak. Roger inspiro is a high performing wireless microphone suited to the needs of teachers and designed for use in both regular and special schools.

Your Roger inspiro is a Swiss premium-quality product developed by Phonak, the world's leading hearing healthcare company.

Please read this User Guide thoroughly to benefit from all the possibilities your Roger inspiro offers.

If you have any questions, please consult your hearing care professional or local Phonak support center.

Phonak – life is on

[www.phonak.com](http://www.phonak.com)





---

## 2. Getting to know your Roger inspiro



### Roger inspiro

- ① On / off slider
- ② Color screen
- ③ Softkeys
- ④ Keypad lock and Back key
- ⑤ Microphone mute



- ⑥ 3.5 mm audio input
- ⑦ Mini-USB for charging



- ⑧ Hook for attaching belt clip and neckloop
- ⑨ Cable wrapper



- iLapel microphone**
- ⑩ Microphone openings
- ⑪ Clothing clip

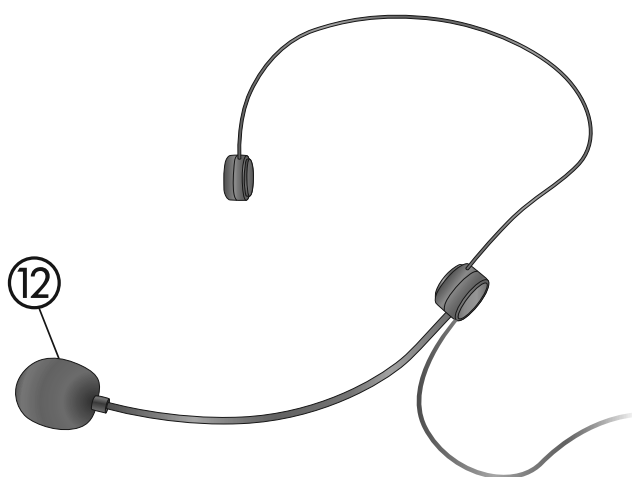

- EasyBoom microphone (optional)**
- ⑫ Microphone

---

## 3. Getting started

### 3.1 Charging Roger inspiro

Roger inspiro contains a built-in rechargeable state-of-the-art lithium polymer battery with fast-charge capability. A fully-discharged battery will reach its maximum charge in approximately 2 hours.

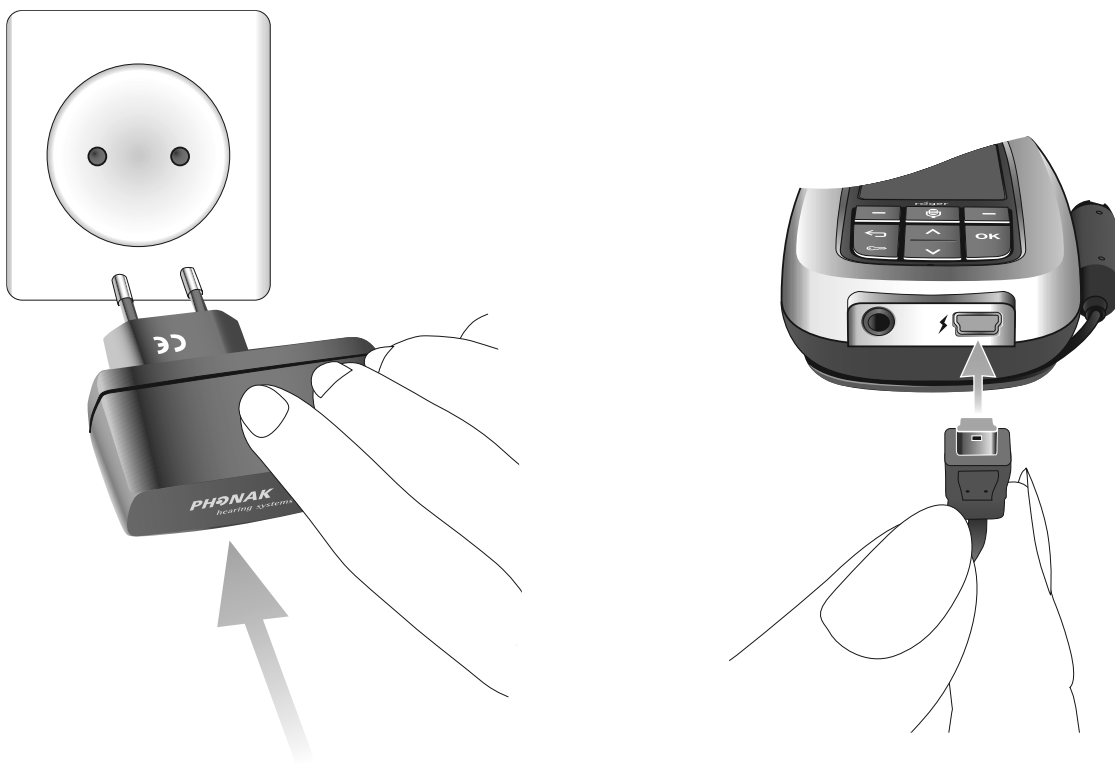

---

The Roger inspiro battery symbol will flash during charging. The battery cannot be over-charged.

Once Roger inspiro is disconnected from its power supply or charging dock, its on-screen battery symbol will show its remaining capacity.

 The battery is fully charged.

Approximately 1 hour before Roger inspiro's battery becomes empty, its vibration alarm will be activated. Check the message on the Roger inspiro's screen and follow the instructions.

Once the Roger inspiro's battery is completely exhausted, its battery symbol will turn red.

① Use only the original Phonak charging unit for Roger inspiro.

---

### 3. Getting started

#### 3.2 Switching Roger inspiro on

To switch on, push the top slider to the left until the green mark appears and the screen is illuminated.

To save power, the backlight of the Roger inspiro LCD will switch off after a few seconds. Pressing any button reactivates this backlight.

To switch Roger inspiro off, push the slider to the right.



- ① After switching Roger inspiro on for the first time, follow the on-screen instructions to set your personal preferences.

---

### 3.3 Wearing Roger inspiro

Roger inspiro can either be clipped to the belt...

... or worn around the neck

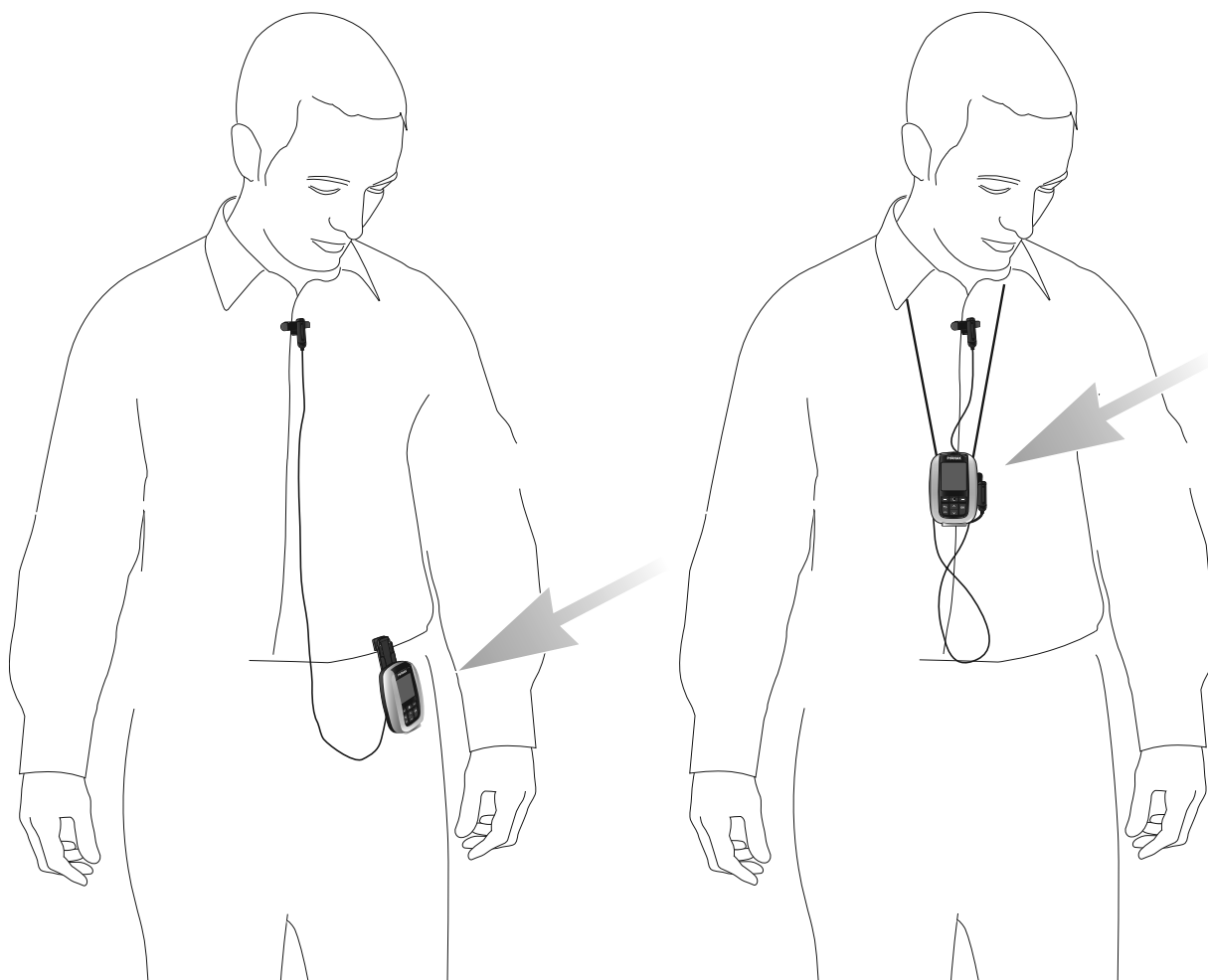

---

### 3. Getting started

Attach the clip to the button on the back of the Roger inspiro.

Make sure it is secure.

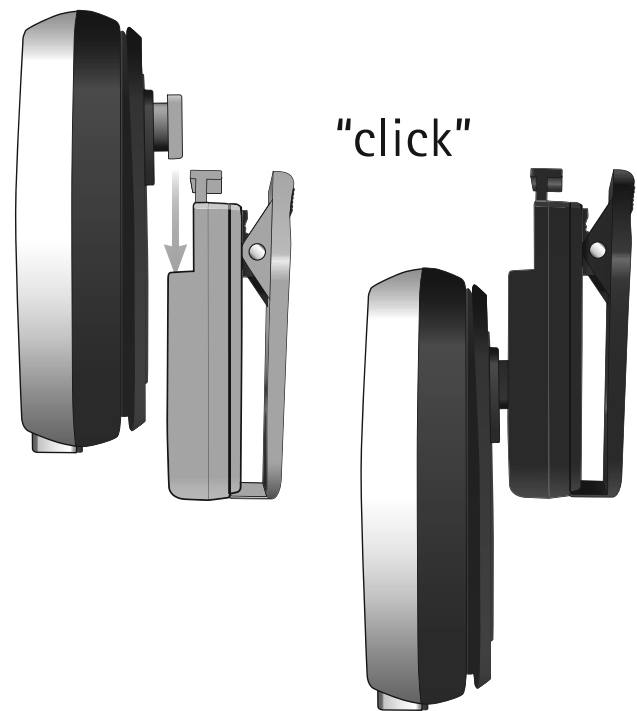

The clip can also be fixed to the belt or trousers before Roger inspiro is attached.

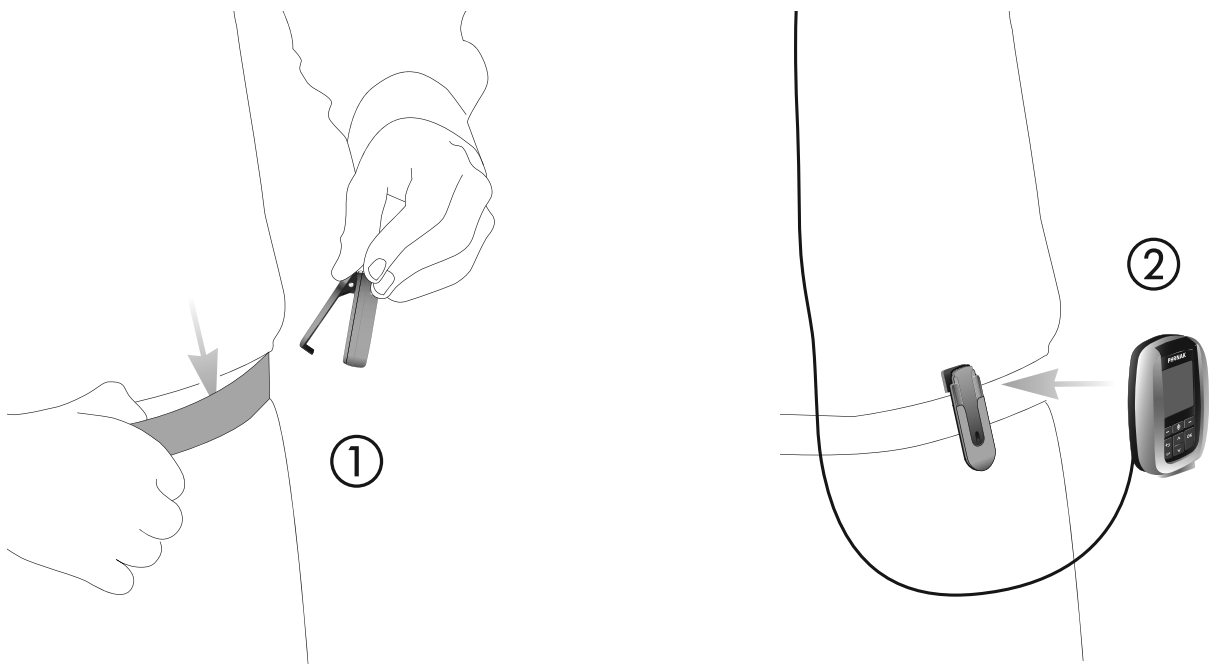

---

To remove the clip, press its top button.

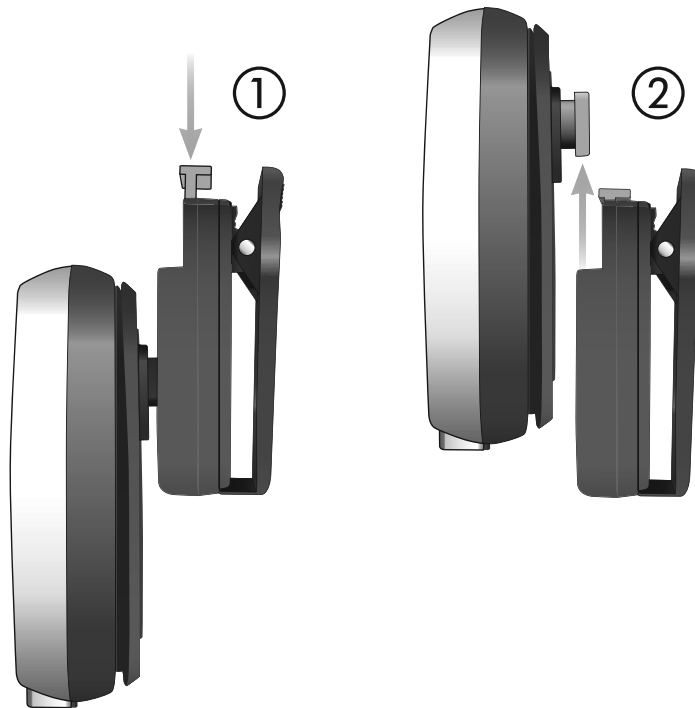



---

### 3. Getting started

Slot the neckloop into Roger inspiro's button.

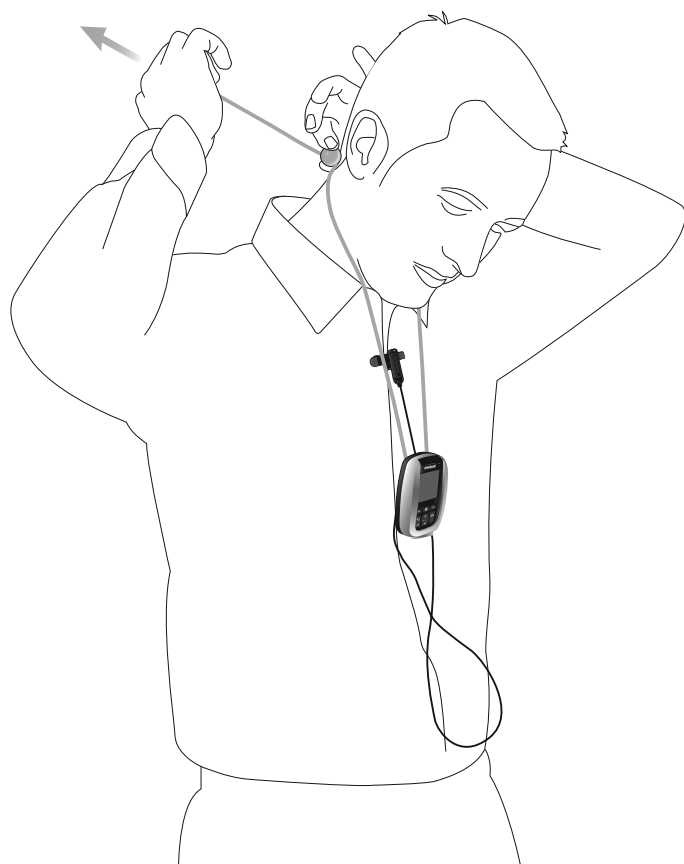

---

### 3.4 Wearing the iLapel microphone

iLapel is an easy-to-use directional lapel microphone which provides excellent sound quality.

- ① You must switch Roger inspiro off before changing the microphone.
- a) Unwind the iLapel from the Roger inspiro.



---

### 3. Getting started

- b) Fix the iLapel to your shirt and ensure the distance between microphone and mouth is approximately 20 cm / 7 inches.

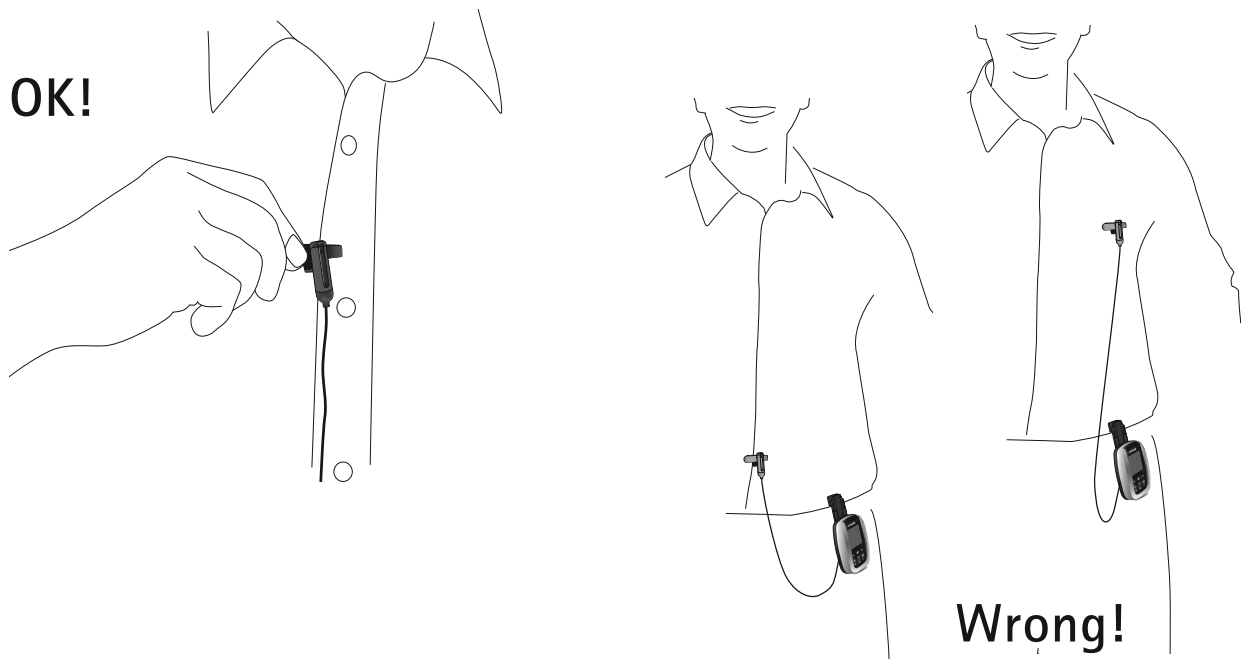

- ⓘ Do not cover either of the two microphone openings!



---

### 3.5 Wearing the optional EasyBoom microphone

EasyBoom is a comfortable, easy-to-use and robust boom microphone, ideal for use in classrooms.

- ① You must switch Roger inspiro off before changing the microphone.

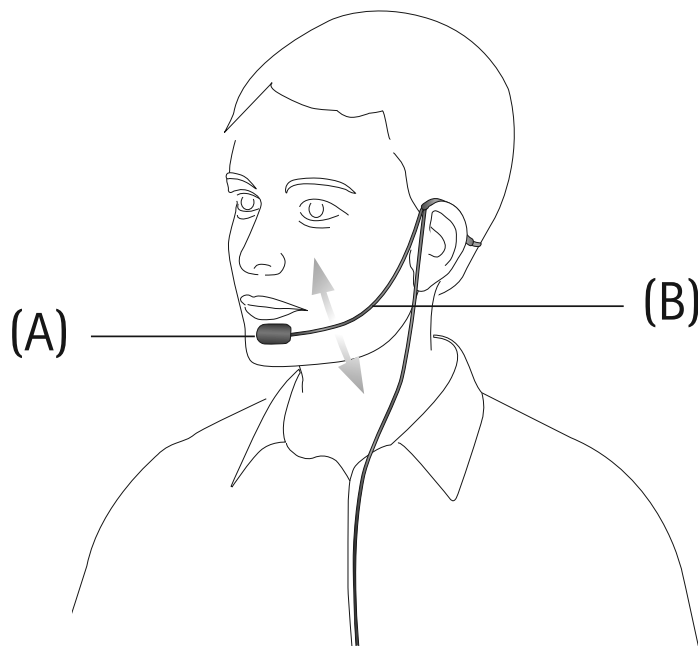

Make sure the head of the microphone is well positioned, as depicted above (A). If required you can easily bend the boom section (B).

---

### 3. Getting started

Fix the clip on your clothing as depicted and ensure the cable is not stretched between the clip and the ear, or the clip and Roger inspiro.

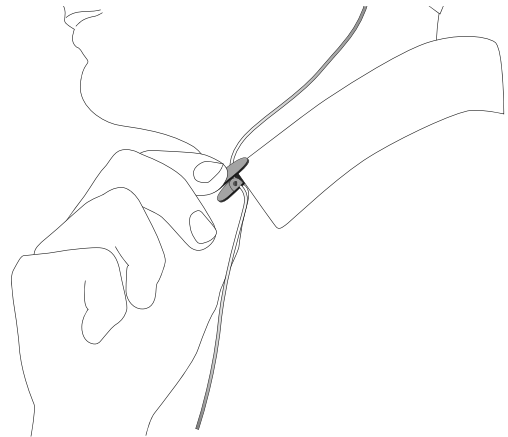

Position the microphone correctly as depicted below.

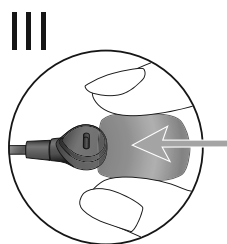
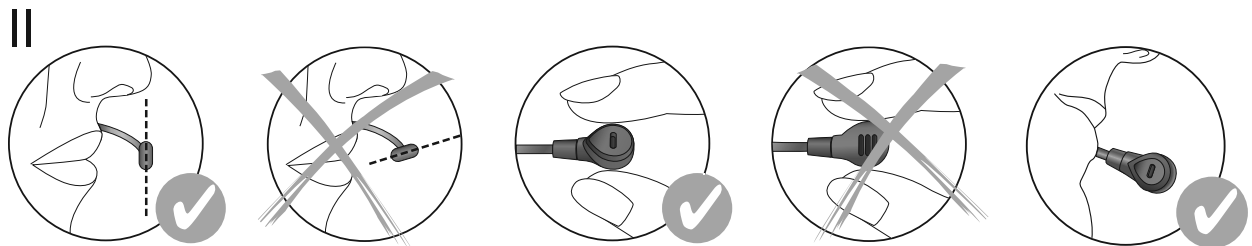
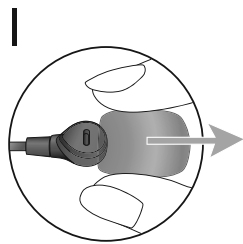



---

## 3.6 Muting the microphone

Roger inspiro's microphone can be muted simply by pressing its microphone key.



- This symbol confirms that the microphone is active: 
- This symbol confirms that the microphone has been muted: 

---

## 3. Getting started

### 3.7 Activating the keypad lock

It is recommended to activate the keypad lock whenever possible.



To activate this, go to the highest menu level (shown right), press the key symbol, then press OK. A key symbol appears in the status bar.







To unlock the keys, repeat the above procedure.

- ① Once the keypad lock has been activated the front keys will be locked. These even remain locked when using the on/off slider.

---

## 4. Using Roger inspiro

### 4.1 How to access Roger inspiro's menu

- Press either Up/Down arrow (  ) or 'OK' (  ) on the keypad. All these keys provide instant access to the main Roger inspiro menu.
- Press Back (  ) to go back a step in the Roger inspiro's menu.
- Press left or right softkeys (the buttons (  ) under the screen) in the Roger inspiro's menu when prompted.

### 4.2 Using Roger inspiro to connect devices in a network (Connect)

A wireless system consists of one or more wireless microphones, which send the voice of the talker (or other incoming audio signal) wirelessly to one or more receivers (worn or used by the listener). To work together in a network, microphones and receivers must be connected. This connection is carried out by pressing the Roger inspiro's Connect softkey. During the connection process, simply hold Roger inspiro close to the device you want to connect.



---

## 4. Using Roger inspiro

### 4.2.1 Connecting Roger receivers

An unlimited number of Roger receivers can be connected with Roger inspiro.

How to connect:

- Turn Roger inspiro on.
- Hold Roger inspiro within 10 cm (4 inches) of the Roger receiver.
- Ear-level Roger receivers must be attached to their respective hearing aids and these hearing aids turned on. Body-worn Roger receivers must be switched on.
- Press the Roger inspiro's right Connect softkey. The receiver will sound confirmation beeps.
- The Roger receiver is now connected with Roger inspiro and the Talker can talk into the Roger inspiro microphone. Repeat these steps to connect any additional receivers.

---

## 4.2.2 Connecting FM receivers

An unlimited number of FM receivers can be connected to Roger inspiro when Roger inspiro is in its Roger + FM application mode. The receivers must be attached to their respective hearing aids and these aids turned on.

How to connect:

- Turn Roger inspiro on.
- Hold Roger inspiro within 10 cm (4 inches) of the receiver.
- Ear-level receivers must be attached to their respective hearing aids and these hearing aids turned on. Body-worn receivers must be switched on.
- Press the Roger inspiro's right Connect softkey. The receiver will sound confirmation beeps.
- The receiver is now connected with Roger inspiro and the Talker can talk into the Roger inspiro microphone. Repeat these steps to connect any additional receivers.

① Roger and FM receivers can be used simultaneously with the same Roger inspiro.

---

## 4. Using Roger inspiro

### 4.2.3 Connecting Roger DigiMaster devices

Roger DigiMaster devices such as the Roger DigiMaster 5000 loudspeaker can also be connected with Roger inspiro.

How to connect:

- Turn Roger inspiro on.
- Hold Roger inspiro within 1 m (40 inches) of the Roger DigiMaster device.
- Turn the Roger DigiMaster on.
- Press the Roger inspiro's right Connect softkey.
- The Roger DigiMaster device is now connected with Roger inspiro and the Talker can talk into the Roger inspiro microphone.

### 4.3 Using Roger inspiro in a classroom network (Primary Talker)

Several transmitter microphones (Roger DynaMic, Roger inspiro etc.) can be used together in a classroom network. The primary Roger inspiro will always have first network priority, while other devices have second priority.

---

Primary Talker mode helps the main talker to lead a classroom discussion involving several wireless Roger microphones. When the main talker speaks, the transmission of any other talkers' voices will be interrupted and the listeners will no longer hear their voices via their receivers, meaning only the primary talker will be heard. The other talkers can then take over during the speech pauses of the main talker.

How to select Primary Talker mode:

- In the Roger inspiro menu go to: Settings / Modes / MTN mode / Primary Talker.

#### **4.4 Using Roger inspiro in a conference room network (Equal Talker)**

Several transmitter microphones (Roger DynaMic, Roger inspiro etc.) can be used together in a conference network. In Equal Talker mode, all these transmitter microphones have equal network priority, meaning talkers will be heard on a first come, first served (i.e. the first talker to speak gets priority).

---

## 4. Using Roger inspiro

How to select Equal Talker mode:

- Go to: Settings / Modes / MTN mode / Equal Talker

### 4.5 Creating a Sub-Network for use by a teaching assistant (SubNet / EndSub)

In a classroom situation teaching assistants sometimes need to provide specific instruction to one or two children. These instructions do not need to be heard by the whole class but only by these specific children. The Roger inspiro's Sub-Network (SubNet) function creates a sub-network that allows the teaching assistant to communicate with these children directly, without disrupting the existing main network.

First, assign the SubNet function to Roger inspiro's left customizable softkey:

- Go to: Settings / Config. SoftKeys / Left SoftKey
- Select the SubNet / EndSub function and press **OK**.
- Press the **←** key to go back to main menu.

Once the left softkey is configured, create the Sub-Network:

- Press the SubNet softkey.

- 
- Hold Roger inspiro less than 10 cm (4 inches) from the receiver and press Connect.

To go back to the main network:

- Press the EndSub left softkey.
- Hold Roger inspiro less than 10 cm (4 inches) from the receiver and press Connect.

#### 4.6 Using Roger inspiro to check devices (Check)

A network device's data can be checked wirelessly using Roger inspiro.

Several types of data can be checked:

- Network status
- Link quality of connected devices
- Stored device data
- Roger DynaMic battery status

How to check a device:

- Turn Roger inspiro and the device on.
- Hold Roger inspiro within 10 cm (4 inches) of the device.

---

## 4. Using Roger inspiro

- Press the left Check softkey.
- The device's data can be read on the Roger inspiro.
- Simply scroll down the data list.

### 4.7 Using Roger inspiro to manage Roger receiver settings (Check / Manage)

Roger receiver settings can also be managed directly from Roger inspiro.

Several settings can be changed:

#### **EasyGain**

Increase or decrease the volume of the Roger receiver.

#### **Default settings**

Reset Roger receiver to its default settings.

How to manage Roger receiver settings:

- Turn Roger inspiro and the Roger receiver on.
- Hold Roger inspiro within 10 cm (4 inches) of the receiver.
- Press the left Check softkey.
- Press the Manage softkey on the right.

- 
- Choose the settings you want to manage from the list and press **OK**.
  - To apply these changes press **OK**.

## CI module

Several settings are available for the miniature universal Roger receiver (Roger X) to suit the CI in question.

<i>CI Module</i>	<i>Suitable for CI (manufacturer / type)</i>
Automatic	All
Setting #1	Advanced Bionic AB / Harmony / Auria / Neptune; Cochlear / Freedom BW / Nucleus 5
Setting #2	Med-El / Opus 2
Setting #3	Neurelec / Digi SPK
Setting #4	
Setting #5	Phonak MicroLink / CI S
Setting #6	Cochlear / Esprit 3G
Setting #7	Neurelec / Digi SP
Setting #8	

- ① Please consult [www.phonak.com](http://www.phonak.com) (support section) to check the CI module settings for the latest CIs on the market.



---

## 5. More detailed information

### 5.1 Checking the Roger inspiro software version

To check which software version Roger inspiro is using, use its 'About Roger inspiro' function.

How to check:

- Go to: Help / About Roger inspiro
- The installed software version will be displayed.

### 5.2 Customizing the softkeys

The functions of Roger inspiro's two softkeys can be customized to help optimize your daily usage.

How to customize the softkeys:

- Go to: Settings / Config Softkey
- Select the Left or Right softkey and press **OK**.
- Select the function you want to assign to the softkey from the list provided, then press **OK**.
- Press **↩** once to also customize the Roger inspiro's second softkey.
- Press the **↩** key several times to go back to the main screen.

- 
- The selected functions for both softkeys will now be displayed on the main screen.

① To restore the softkeys to their default configuration, the Default softkey is available (Settings / Config Softkeys / Default).

### 5.3 Changing the Application mode

Roger inspiro can run in two application modes:

**Roger mode:** to use Roger inspiro with the Roger receivers and Roger DigiMasters.

**Roger + FM mode:** to use Roger inspiro with the Roger receivers, Roger DigiMasters and FM receivers.

How to change the Application mode:

- Go to: Settings / Modes / Application mode
- Select the required application mode in the menu.
- Roger inspiro will automatically restart in the chosen application mode.

---

## 5. More detailed information

### 5.4 Adjusting the audio volume of Roger DigiMaster loudspeakers

This can be done wirelessly using Roger inspiro.

How to change Roger DigiMaster's volume:

- Go to: SoundField / Adjust volume
- Use the Up / Down arrow keys to adjust the Roger DigiMaster's volume.

### 5.5 Adjusting the volume of a Roger DigiMaster's external audio input

Once an audio or multimedia device has been connected (via cable) to the external audio input of a Roger DigiMaster loudspeaker, the volume of the audio device can be adjusted either directly on the device itself or using Roger inspiro's 'Adjust ext audio' function.

How to adjust the external audio input volume:

- Go to: SoundField / Adjust ext audio
- Use the Up / Down arrow keys to adjust the volume.

---

## 5.6 Joining an existing network (JoinNet)

If a network already exists, Roger inspiro can simply join this network.

How to join an existing network:

- Hold Roger inspiro within 10 cm (4 inches) of any device that is already connected to the network.
- Go to: Network / JoinNet
- Roger inspiro will join the existing network.

## 5.7 Creating a new network ID (NewNet)

To create a new network within the same operating range (i.e. room or department) as an existing network, it is necessary to create a new network ID.

- ① Creating a new network ID will erase all the existing network data in your Roger inspiro and there is no way to revert back to the previous network ID.

How to create a new network ID:

- Go to: Network / Create NewNet

---

## 5. More detailed information

### 5.8 Viewing list of connected devices

This function shows which microphones or Roger Dynamic SoundField devices are currently connected to a network. These devices must be switched on.

To View MultiTalkers (transmitter microphones such as Roger inspiro, Roger DynaMic etc.):

- Go to: Network/View MultiTalkers

To View Roger DigiMasters (Roger Dynamic SoundField devices):

- Go to: SoundField/View DigiMasters

- ⓘ The 'View list of connected devices' function does not apply to receivers.

---

## 5.9 Viewing a device's total usage time

The total usage time of any Roger device refers to the time during which that device has been used (since its purchase or last service). This time can be viewed using the primary Roger inspiro's Check function.

How to view a device's total usage time:

- Ensure both Roger inspiro and the device are turned on.
- Hold Roger inspiro within 10 cm (4 inches) of the device in question.
- Press the left Check softkey.
- Scroll down the data list to view the time.

### 5.9.1 Viewing Roger inspiro's total usage time

Roger inspiro's total usage time can be checked directly in the Roger inspiro itself.

How to select:

- Go to: Settings / DataLogging
- Read Roger inspiro's total usage time.

---

## 5. More detailed information

### 5.10 Changing Roger inspiro's FM channel

The FM channel in Roger inspiro can easily be changed.

How to change Roger inspiro's FM channel:

- Go to: FM / Change channel
- Select the required FM channel and press **OK**.
- The selected FM channel will be activated.
- Press Connect to connect FM receivers with the newly selected FM channel.

### 5.11 Finding a new FM channel in the Roger inspiro

This function locates a new unused FM channel.

How to find a new FM channel:

- Turn Roger inspiro on and hold within 10 cm (4 inches) of the FM receiver.
- Ear-level receivers must be attached to their respective hearing aids and these hearing aids turned on. Body-worn receivers must be switched on.
- Go to: FM / Find channel
- Press Yes or No when prompted.

---

## 5.12 Changing FM receiver settings

FM receiver settings can be managed directly from Roger inspiro.

Several functions are available:

### Scan for channels

Searches for an existing transmission from another wireless microphone, e.g. if a speaker is already using an FM microphone at a lecture or presentation.

### Identify receivers

Helps to identify a receiver. Relevant receiver data can then be read and displayed on the Roger inspiro's screen (e.g. the user of the receiver or the serial number).

### View channels

Displays the channels currently programmed into the receiver.

### Set FM volume

Increases or decreases the volume of the FM receiver.



---

## 5. More detailed information

### Change channel

Changes the receiver's channel without changing the current Roger inspiro channel. This can be useful if several working groups need to be created in a class.

### Set beep tone

Choose between the different beeping tones available to indicate when the FM receivers are being synchronized or monitored.

### Lock push button

Locks or unlocks the push button of the universal FM receiver.

How to change FM receiver settings:

- Turn Roger inspiro and the receiver on.
- Hold Roger inspiro within 10 cm (4 inches) of the receiver.
- Press the left Check softkey.
- Press the right Manage softkey.
- Select the setting to be changed from the list and press **OK**.
- Follow Roger inspiro's subsequent instructions.

---

## 5.13 Re-activating the first-time use menu

The Roger inspiro is pre-configured in our factory. However after switching Roger inspiro on for the first time, you are given the option of changing the Roger inspiro's configuration. To ensure you are asked about this configuration again when you next turn on Roger inspiro, select Reactivate and reboot the device.

How to re-activate the first-time use menu:

- Go to: Settings / Modes / Reconfiguration / Re-activate
- Switch Roger inspiro off and on again.

---

## 5. More detailed information

### 5.14 Changing menu type

Two types of menu are available: Full provides access to the complete Roger inspiro menu, while 'Quick' suits less advanced users who do not require access to all of Roger inspiro's features.

How to change the menu type:

- Switch on Roger inspiro.
- When the microphone symbol appears in the top left corner of the Roger inspiro screen, press **OK** and the left softkey simultaneously, then press **OK** again.
- Select the menu type you prefer then **OK**.

### 5.15 Connecting audio devices with Roger inspiro

Roger inspiro can be directly connected to any audio device via Roger inspiro's audio input socket.

How to connect an audio device:

- Plug a 3.5 mm audio cable into the audio device's headphone jack.
- Plug the cable's other end into the Roger inspiro audio jack input (at the base of the device).

- 
- The audio symbol  will appear on the Roger inspiro's display.

Each type of audio device has a specific audio impedance output. Roger inspiro's audio input type can be set to reflect this more accurately.

How to set the Roger inspiro audio input:

- Go to: Settings / audio input
- Select the audio device and press .

① For permanent connection between an audio device and Roger inspiro, it is recommended to use the Roger AudioHub device. This product allows one or two audio sources to be wirelessly connected to Roger inspiro, Roger DigiMaster devices and Phonak receivers.

## 5.16 Verification mode

The Verification mode is a mode for Professionals to verify a device according to the iPOP (Phonak Operation Protocol).

---

## 5. More detailed information

How to activate Verification mode:

- Go to: Settings / Verification / Activate
- The device will restart automatically in Verification mode.

① When the device is switched off, Verification mode will be automatically deactivated.

### 5.17 Roger inspiro settings

Under Settings in the menu different Roger inspiro settings can be changed.

#### Setting language

Choose Roger inspiro's on-screen language.

#### Setting the Roger inspiro desktop image

Choose the desktop image you prefer.

#### Setting date & time

Set the date and time as well as their format.

---

## Setting alarm

Roger inspiro features a basic daily alarm function. Here you can set the time of this alarm.

When the alarm has been set, the alarm symbol  will be shown at the top of Roger inspiro's screen.

① This alarm will sound only when Roger inspiro is already switched on.

## Setting the Roger inspiro display

Set Roger inspiro's display parameters.

## Viewing Roger inspiro battery status

View battery status.

## 5.18 Help

### Help index

Summarizes all Roger inspiro's help topics.

### Web support

Displays a website that provides further useful information for users, teachers and parents.

---

## 5. More detailed information

### **About Roger inspiro**

Shows the device's serial number, software version, hardware version, and device settings.

### **5.19 Technical data**

#### **Roger wireless technology standard**

Roger is a digital wireless technology standard, allowing for long range, ultra-low delay, broadband audio broadcast to miniature low power receivers. Roger is compatible with all brands of hearing aids, cochlear implants, Roger Dynamic SoundField and solutions for listeners with normal hearing. Roger operates in the 2.4 GHz band and is globally license free. Roger offers unprecedented speech understanding in noise and ease of use.

#### **Operating range**

Indoor: approx. 15 meters / 50 feet

Outdoor: approx. 50 meters / 170 feet

#### **Battery operating time**

Approx. 12 hours

Charging time: approx. 2 hours

---

## 5.20 About accessories

Specific accessories are available for Roger inspiro.  
Please visit [www.phonak.com](http://www.phonak.com) to learn more.



---

## 6. Troubleshooting

The following is a summary of frequently asked questions and the answers to them.

<i>Most probable cause</i>	<i>Solution</i>
<b>Roger inspiro cannot be switched on</b>	
■ The battery is run down	■ Charge the Roger inspiro for at least two hours
<b>Poor speech intelligibility</b>	
■ The microphone is not positioned properly	■ Move the microphone closer to the speaker's mouth
<b>Speaker's voice is inaudible even though Roger inspiro is turned on</b>	
■ The microphone has been muted. Or...	■ Check Roger inspiro's screen display and press the microphone mute key in order to activate the microphone
■ The hearing device has not been set to the correct program. Or...	■ Connect the receiver and check that it is set to the correct mode (DAI, EXT,FM)
■ The Roger Dynamic SoundField system has not been correctly set-up. Or...	■ Connect or switch on or check the volume settings of the Roger Dynamic SoundField system
■ SubNet function is activated	■ Press EndSub

<i>Most probable cause</i>	<i>Solution</i>
<b>Roger inspiro does not respond to commands</b>	
<ul style="list-style-type: none"> <li>■ Software issue</li> </ul>	<ul style="list-style-type: none"> <li>■ Reboot Roger inspiro by simultaneously pressing its four side buttons</li> </ul>
<b>FM receiver cannot be connected to Roger inspiro</b>	
<ul style="list-style-type: none"> <li>■ FM application mode is not active</li> </ul>	<ul style="list-style-type: none"> <li>■ Select the Roger + FM application mode under Settings / Modes / Application Mode</li> </ul>
<b>Whistling sound from Roger DigiMaster loudspeaker</b>	
<ul style="list-style-type: none"> <li>■ Audio feedback between loudspeaker and microphone</li> </ul>	<ul style="list-style-type: none"> <li>■ Move away from Roger DigiMaster loudspeaker and / or reduce Roger inspiro's volume</li> </ul>
<b>Interruptions in audio transmission</b>	
<ul style="list-style-type: none"> <li>■ Distance between Roger inspiro and receivers is too large</li> </ul>	<ul style="list-style-type: none"> <li>■ Reduce distance between Roger inspiro and receivers</li> </ul>
<b>Volume of Audio Line-in device is too low</b>	
<ul style="list-style-type: none"> <li>■ Incorrect volume settings</li> </ul>	<ul style="list-style-type: none"> <li>■ Increase volume on audio source or change audio input settings on Roger inspiro</li> </ul>

---

## 6. Troubleshooting

*Most probable cause*

*Solution*

### Unintended talker can be heard in receivers

■ Talker has not muted or turned off their Roger inspiro (i.e. when leaving the room)

■ Mute or turn off talker's Roger inspiro

---

## 7. Important information

 Please read the information on the following pages before using your Phonak Roger inspiro.

### 7.1 Hazard warnings

 Keep this device out of reach of children under 3 years.

 Opening the Roger inspiro might damage it. If problems occur which cannot be resolved by following the remedy guidelines in the troubleshooting section of this user guide, consult your hearing care professional.

 The Roger inspiro may only be repaired by an authorized service center. Changes or modifications to the device that were not explicitly approved by Phonak are not permitted.

 Dispose of electrical components in accordance with your local regulations.

---

## 7. Important information

- ⚠ Do not use your Roger inspiro in areas where electronic equipment is prohibited. If in doubt, please ask the person in charge.
- ⚠ Roger inspiro should not be used on aircrafts unless specifically permitted by the flight personnel.
- ⚠ External devices may only be connected if they have been tested in accordance with corresponding IECXXXXX standards.
- ⚠ Only use accessories approved by Phonak AG.
- ⚠ Using your Roger inspiro cables in any way contradictory to their intended purpose can cause injury.
- ⚠ When operating machinery, ensure that no parts get caught in the machine.
- ⚠ Do not charge Roger inspiro while it is on your body.
- ⚠ Caution: electric shock. Do not insert plug alone into electrical outlets.

---

## 7.2 Product safety information

- ① Protect the Roger inspiro from excessive moisture (bathing, swimming), heat (radiator, car dashboard), and direct skin contact when sweating (workout, fitness, sport).
- ① X-ray radiation, CT or MRI scans may destroy or adversely affect the correct functioning of the Roger inspiro.
- ① Protect the Roger inspiro from excessive shock and vibration.
- ① Do not expose your Roger inspiro to temperatures and humidity outside of the recommended conditions stated in this user guide.
- ① Do not use excessive force when connecting your Roger inspiro to the different cables.
- ① Protect all openings (microphones, audio input and charger) from dirt and debris.

---

## 7. Important information

- ① If the Roger inspiro has been dropped or damaged, if it's overhead during charging, has a damaged cord or plug, or has been dropped into liquid, discontinue use of Roger inspiro and contact your hearing healthcare professional.
- ① Never use a microwave or other heating devices to dry the device.
- ① Clean the Roger inspiro using a damp cloth. Never use household cleaning products (washing powder, soap, etc.) or alcohol to clean the Roger inspiro.
- ① For safety reasons, recharge the Roger inspiro only with chargers delivered by Phonak or by stabilized chargers providing 5VDC and  $\geq 500$  mA.
- ① Do not connect an USB or audio cable exceeding 3 meters (9 ft) in length to the Roger inspiro.
- ① When the Roger inspiro is not in use, turn it off and store it safely.

- 
- ① The Roger inspiro has a built-in rechargeable battery. This battery can be charged and discharged hundreds of times but may eventually wear out.
  - ① The battery may only be replaced by authorized personnel.

### 7.3 Other important information

- High-powered electronic equipment, larger electronic installations and metallic structures may impair and significantly reduce the operating range.
- Roger inspiro collects and stores internal technical data. This data may be read by a hearing care professional in order to check the device, as well as to support you in being able to use the device in the ideal manner.
- Persons with pacemakers or other medical devices should ALWAYS consult their physician, the manufacturer of their pacemaker, or other medical device BEFORE using the Roger inspiro. The use of Roger inspiro with a pacemaker or other medical devices



---

## 7. Important information

should ALWAYS be in accordance with the safety recommendations of the physician responsible for your pacemaker or the pacemaker manufacturer.

- The digital signal sent from the Roger inspiro transmitter microphone to a connected receiver cannot be overheard by other devices which are not in the network of the transmitter microphones.
- Your Roger inspiro is approved to operate at a radio frequency that is specific to your country or region and might not be approved for use outside your country or region. Be aware that operation during international travel may cause interference with other electronic devices, or other electronic devices may cause interferences with your Roger inspiro.
- Be aware that the FM radio signals might also be picked up and overheard by other FM receivers.
- Be aware that the wireless transmission from the transmitter microphone to the receiver may be interrupted due to interferences or out of range reasons and that words which has been spoken by

---

the wearer of the transmitter microphone may not be heard by the wearer of the receiver.

- Avoid direct contact of the receiver with hair spray or other cosmetic chemicals.
- Sensitivity of the hearing aid microphone may be lowered with the use of this system and therefore, environmental awareness may be reduced.
- Universal receivers may create a loud beep at start-up which could be annoying for Cochlear Implant users. Please contact your hearing care healthcare professional for options to eliminate the beep.

---

## 8. Service and warranty

### 8.1 Local warranty

Please ask the hearing care professional, where you purchased your device, about the terms of the local warranty.

### 8.2 International warranty

Phonak offers a one-year limited international warranty, valid as of the date of purchase. This limited warranty covers manufacturing and material defects. The warranty only comes into force if proof of purchase is shown.

The international warranty does not affect any legal rights that you might have under applicable national legislation governing sale of consumer goods.

---

### 8.3 Warranty limitation

This warranty does not cover damage from improper handling or care, exposure to chemicals, immersion in water or undue stress. Damage caused by third parties or non-authorized service centers renders the warranty null and void. This warranty does not include any services performed by a hearing care professional in their office.

Serial number:

\_\_\_\_\_

Authorized hearing  
care professional  
(stamp/signature):

Date of purchase:

\_\_\_\_\_

\_\_\_\_\_

---

## 9. Information and explanation of symbols



With the CE symbol, Phonak AG confirms that this Phonak product meets the requirements of the Medical Devices Directive 93/42/EEC as well as the R&TTE Directive 1999/5/EC on radio and telecommunications equipment.



The alert sign means that potential restrictions on its use are applicable in one or more EU Member States.



This symbol indicates that it is important for the user to read and take into account the relevant information in this user guide.



This symbol indicates that it is important for the user to pay attention to the relevant warning notices in these user guides.



Important information for handling and product safety.

---

### Operating conditions

This device is designed such that it functions without problems or restrictions if used as intended, unless otherwise noted in these user guides.  
0° to +40° Celsius (+32° to +104° Fahrenheit) and relative humidity of <95% (non condensing).

---

### Transport and storage conditions

During transport or storage, the temperature should not exceed the limit values of -20° to +60° Celsius

---

## 9. Information and explanation of symbols

(-4° to +140° Fahrenheit) and relative humidity of 90% for a long period of time. The air pressure between 500 hPa and 1100 hPa is appropriate.



The symbol with the crossed-out garbage bin is to make you aware that this device may not be thrown away as normal household waste. Please dispose of old or unused device, at waste disposal sites intended for electronic waste, or give your device to your hearing care professional for disposal. Proper disposal protects the environment and health.

This product has an embedded, non-replaceable battery. Do not attempt to open the product or remove the battery as this may cause injury and damage the product.

Please contact the local recycling facility for removal of the battery.

